

SKKT 20, SKKT 20B



SEMIPACK® 1

Thyristor / Diode Modules

SKKT 20
SKKT 20B

Features

- Heat transfer through aluminium oxide ceramic isolated metal baseplate
- Hard soldered joints for high reliability
- UL recognized, file no. E 63 532

Typical Applications

- DC motor control (e. g. for machine tools)
- AC motor soft starters
- Temperature control (e. g. for ovens, chemical processes)
- Professional light dimming (studios, theaters)

1) See the assembly instructions

V_{RSM} V	V_{RRM}, V_{DRM} V	$I_{TRMS} = 40$ A (maximum value for continuous operation)	
		$I_{TAV} = 20$ A (sin. 180; $T_c = 80$ °C)	
900	800	SKKT 20/08E	SKKT 20B08E
1300	1200	SKKT 20/12E	SKKT 20B12E
1500	1400	SKKT 20/14E	SKKT 20B14E
1700	1600	SKKT 20/16E	SKKT 20B16E

Symbol	Conditions	Values	Units
I_{TAV}	sin. 180; $T_c = 85$ (100) °C;	18 (13)	A
I_D	P3/180; $T_a = 45$ °C; B2 / B6	31 / 38	A
	P3/180F; $T_a = 35$ °C; B2 / B6	46 / 60	A
I_{RMS}	P3/180; $T_a = 45$ °C; W1 / W3	42 / 3 * 30	A
I_{TSM}	$T_{vj} = 25$ °C; 10 ms	320	A
	$T_{vj} = 125$ °C; 10 ms	280	A
i^2t	$T_{vj} = 25$ °C; 8,3 ... 10 ms	510	A ² s
	$T_{vj} = 125$ °C; 8,3 ... 10 ms	390	A ² s
V_T	$T_{vj} = 25$ °C; $I_T = 75$ A	max. 2,3	V
$V_{T(TO)}$	$T_{vj} = 125$ °C	max. 1	V
r_T	$T_{vj} = 125$ °C	max. 16	mΩ
I_{DD}, I_{RD}	$T_{vj} = 125$ °C; $V_{RD} = V_{RRM}, V_{DD} = V_{DRM}$	max. 10	mA
t_{gd}	$T_{vj} = 25$ °C; $I_G = 1$ A; $di_G/dt = 1$ A/μs	1	μs
t_{gr}	$V_D = 0,67 * V_{DRM}$	1	μs
$(di/dt)_{cr}$	$T_{vj} = 125$ °C	max. 150	A/μs
$(dv/dt)_{cr}$	$T_{vj} = 125$ °C	max. 1000	V/μs
t_q	$T_{vj} = 125$ °C	80	μs
I_H	$T_{vj} = 25$ °C; typ. / max.	100 / 200	mA
I_L	$T_{vj} = 25$ °C; $R_G = 33$ Ω; typ. / max.	250 / 400	mA
V_{GT}	$T_{vj} = 25$ °C; d.c.	min. 3	V
I_{GT}	$T_{vj} = 25$ °C; d.c.	min. 150	mA
V_{GD}	$T_{vj} = 125$ °C; d.c.	max. 0,25	V
I_{GD}	$T_{vj} = 125$ °C; d.c.	max. 5	mA
$R_{th(j-c)}$	cont.; per thyristor / per module	1,2 / 0,6	K/W
$R_{th(j-c)}$	sin. 180; per thyristor / per module	1,3 / 0,65	K/W
$R_{th(j-c)}$	rec. 120; per thyristor / per module	1,35 / 0,68	K/W
$R_{th(c-s)}$	per thyristor / per module	0,2 / 0,1	K/W
T_{vj}		- 40 ... + 125	°C
T_{stg}		- 40 ... + 125	°C
V_{isol}	a. c. 50 Hz; r.m.s.; 1 s / 1 min.	3600 / 3000	V~
M_s	to heatsink	5 ± 15 % ¹⁾	Nm
M_t	to terminal	3 ± 15 %	Nm
a		5 * 9,81	m/s ²
m	approx.	95	g
Case	SKKT	A 46	
	SKKT ...B	A 48	

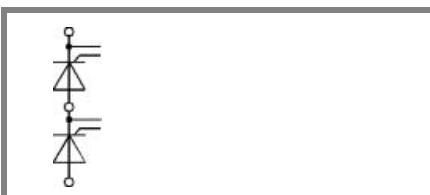

SKKT

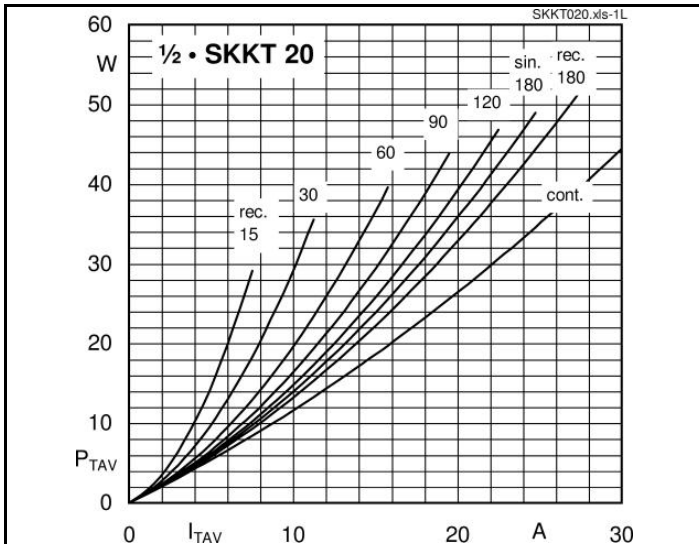

Fig. 1L Power dissipation per thyristor vs. on-state current

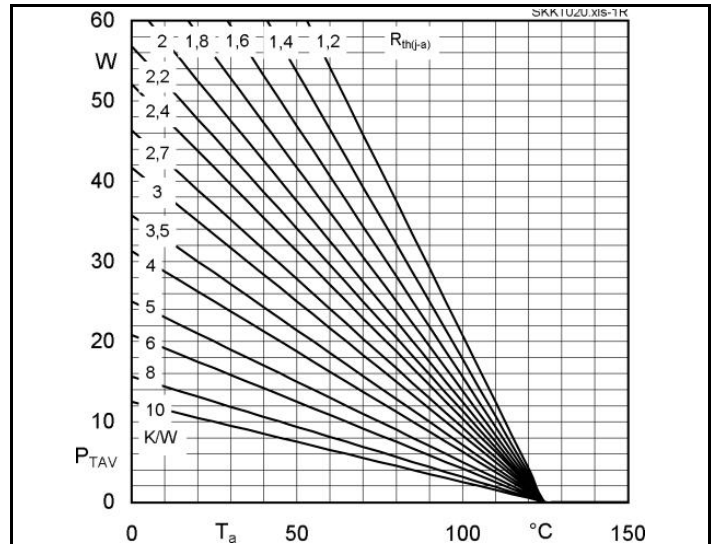

Fig. 1R Power dissipation per thyristor vs. ambient temp.

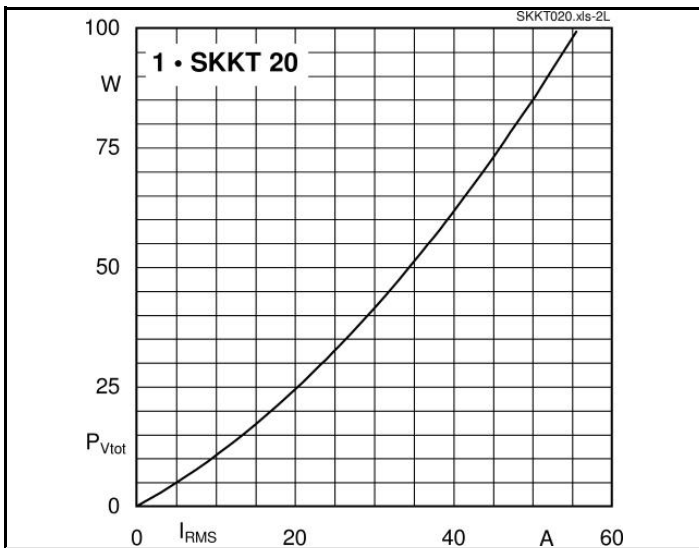

Fig. 2L Power dissipation per module vs. rms current

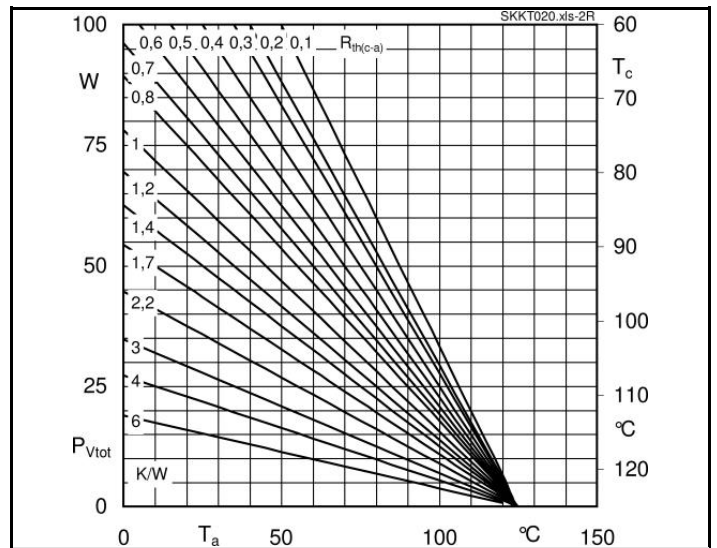

Fig. 2R Power dissipation per module vs. case temp.

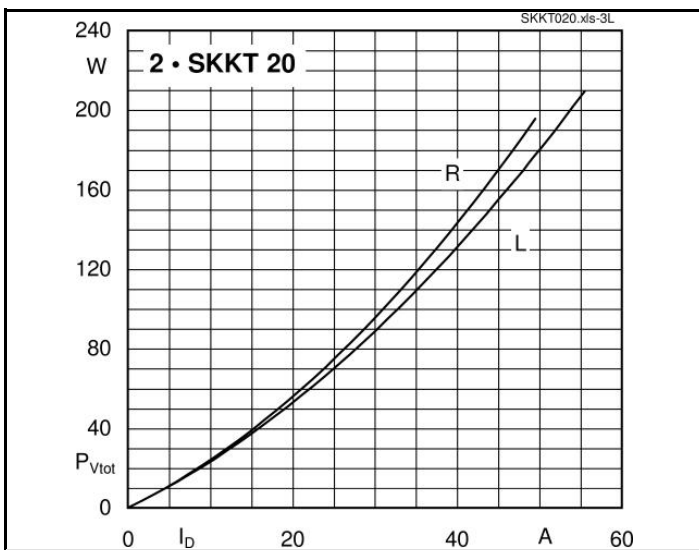

Fig. 3L Power dissipation of two modules vs. direct current

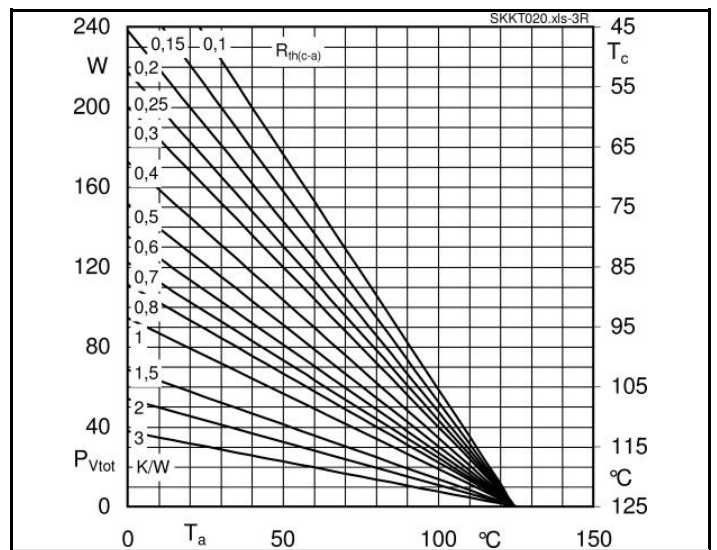
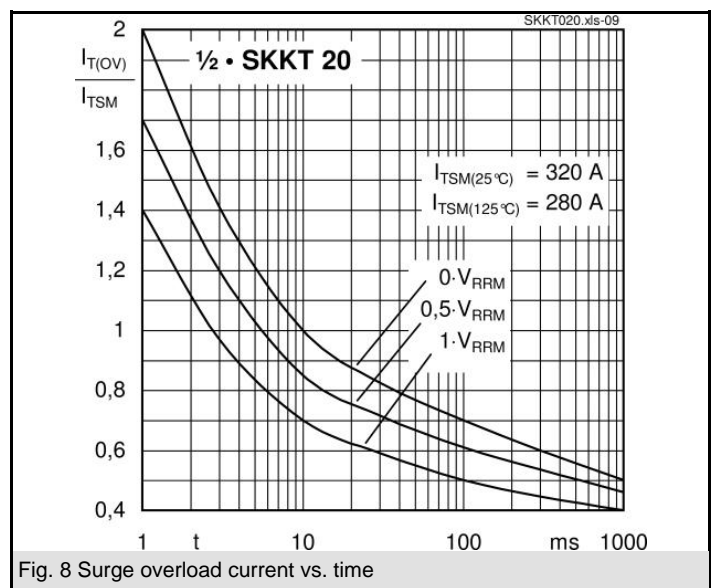
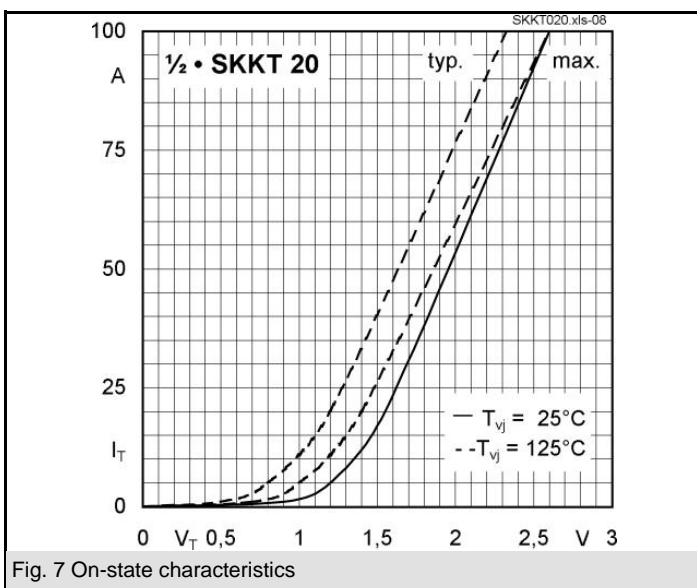
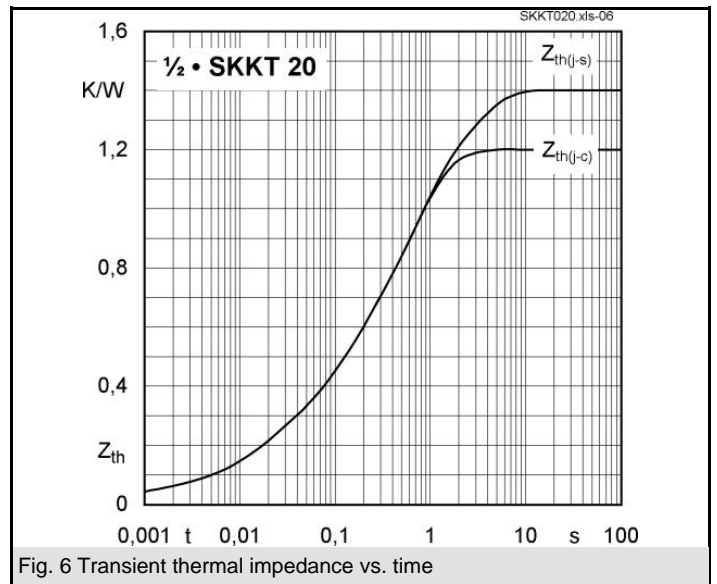
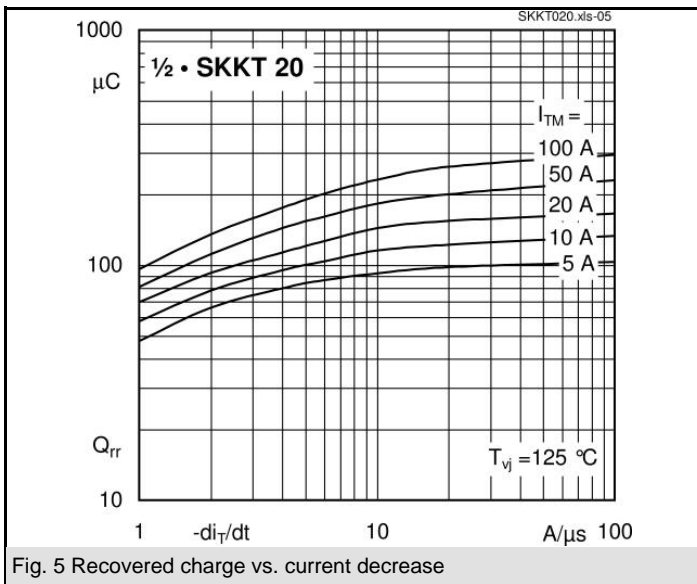
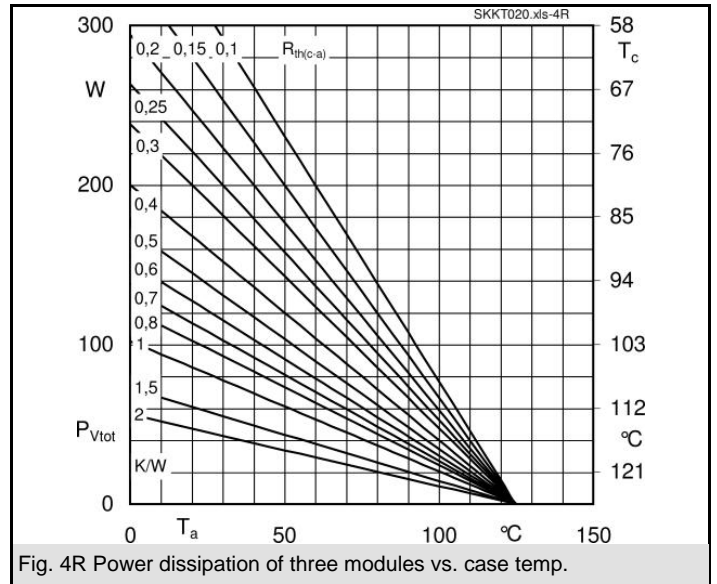
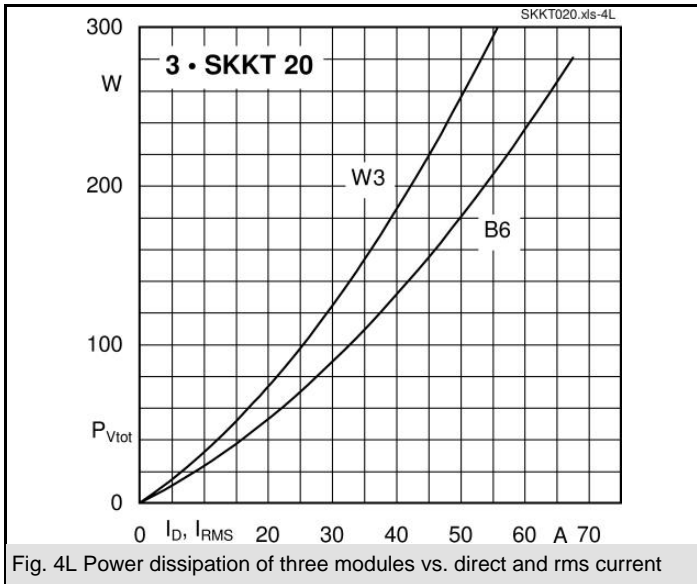
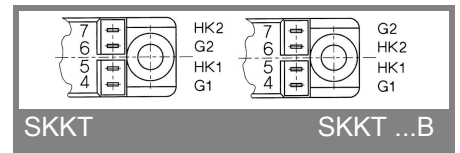
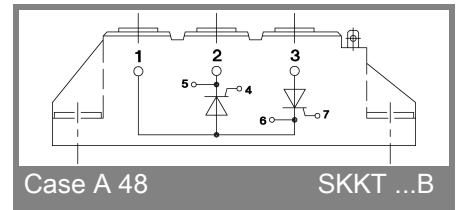
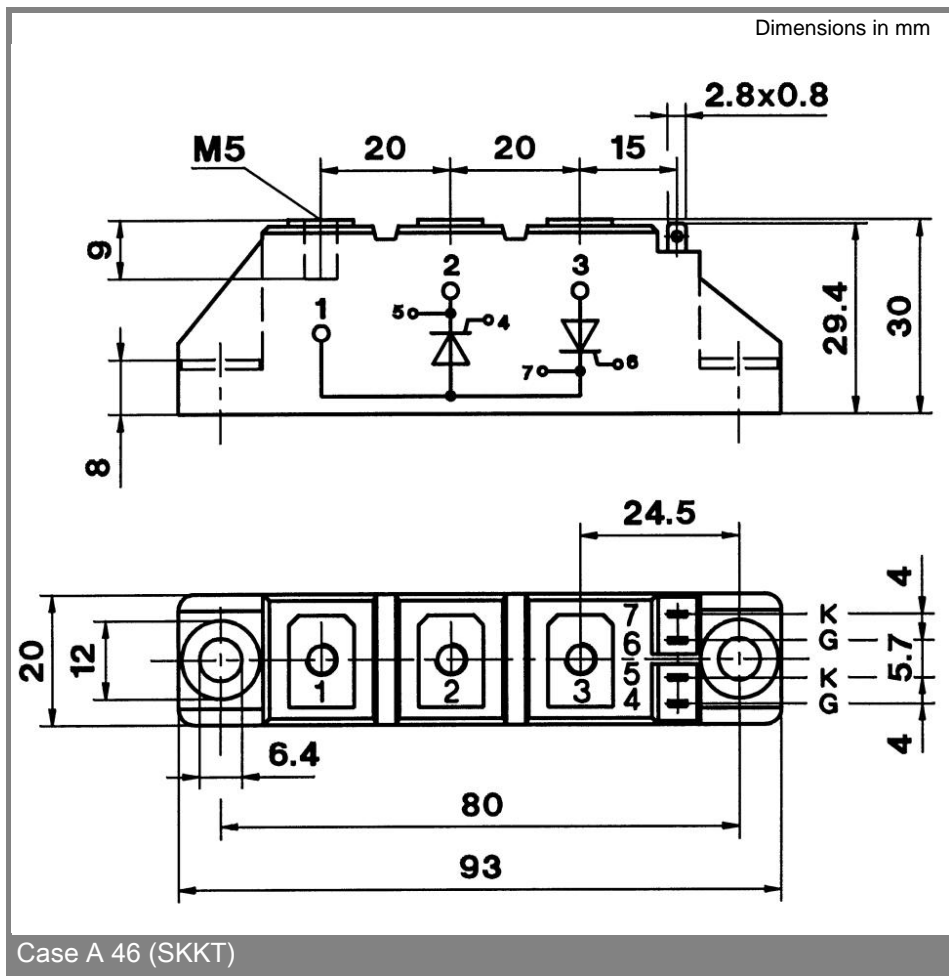
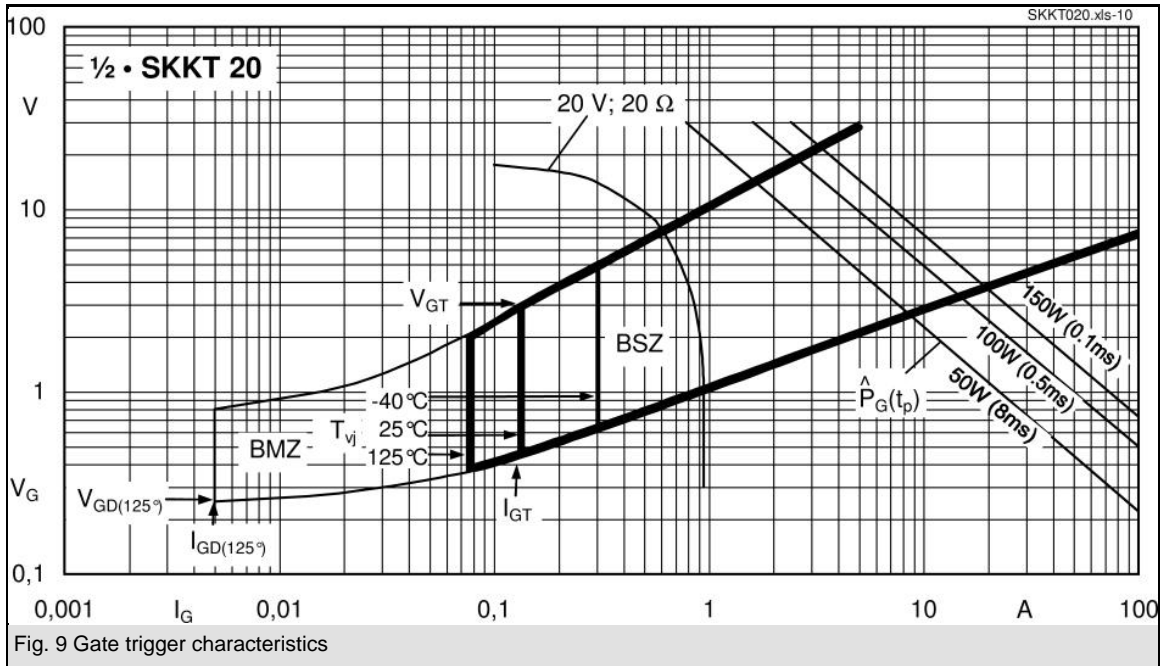

Fig. 3R Power dissipation of two modules vs. case temp.

SKKT 20, SKKT 20B





This technical information specifies semiconductor devices but promises no characteristics. No warranty or guarantee expressed or implied is made regarding delivery, performance or suitability.